









24

	<b>SERVICE</b>  → 
	(0) 91 23 95 50  (0) 17 18 11 43 24 
	(0) 91 23 18 51 55 (0) 91 23 18 52 19 (0) 91 23 30 85
	Service + Spare parts e-mail: <a href="mailto:service@tadanofaun.de">service@tadanofaun.de</a> e-mail: <a href="mailto:spareparts@tadanofaun.de">spareparts@tadanofaun.de</a>
	 → <b>++49</b>

TADANO FAUN GmbH  
 Postfach 10 02 64  
 D-91205 Lauf/Germany  
 Tel. (0) 91 23 95 50  
 Fax (0) 91 23 30 85  
<http://www.tadanofaun.de>  
 e-mail: [info@tadanofaun.de](mailto:info@tadanofaun.de)

ALL-TERRAIN  
**ATF 100-5**

ISO 9001

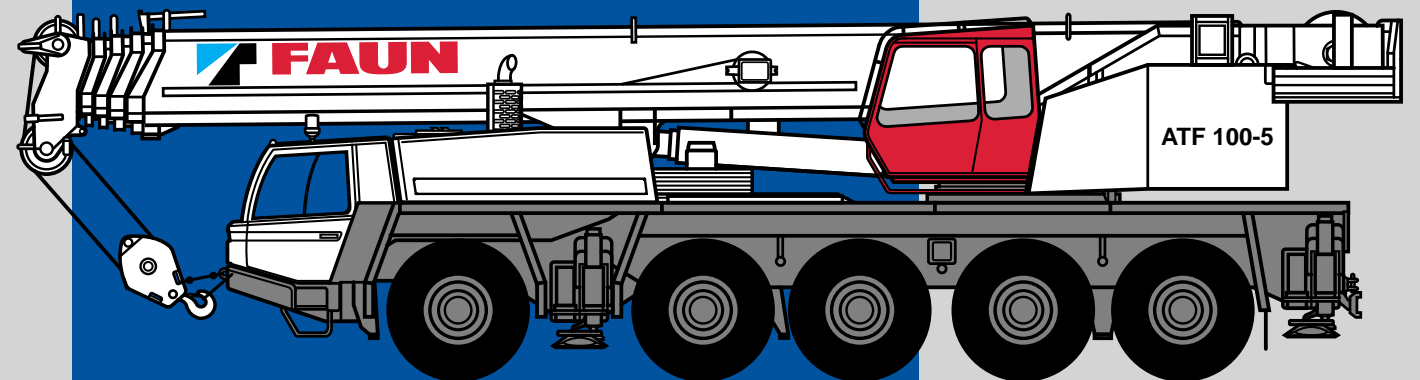

Maße (mm)  
 Dimensions (mm)  
 Dimensiones (mm)

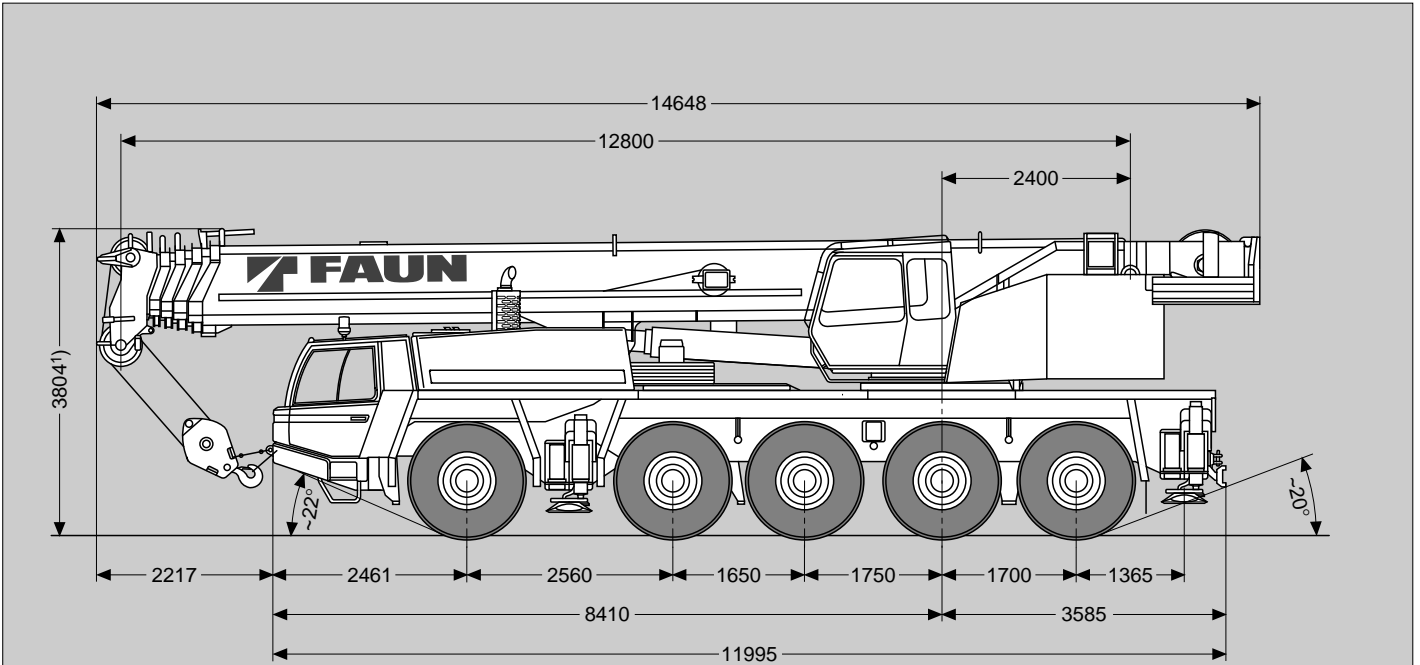
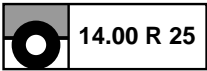

1) - 126 mm/+ 148 mm

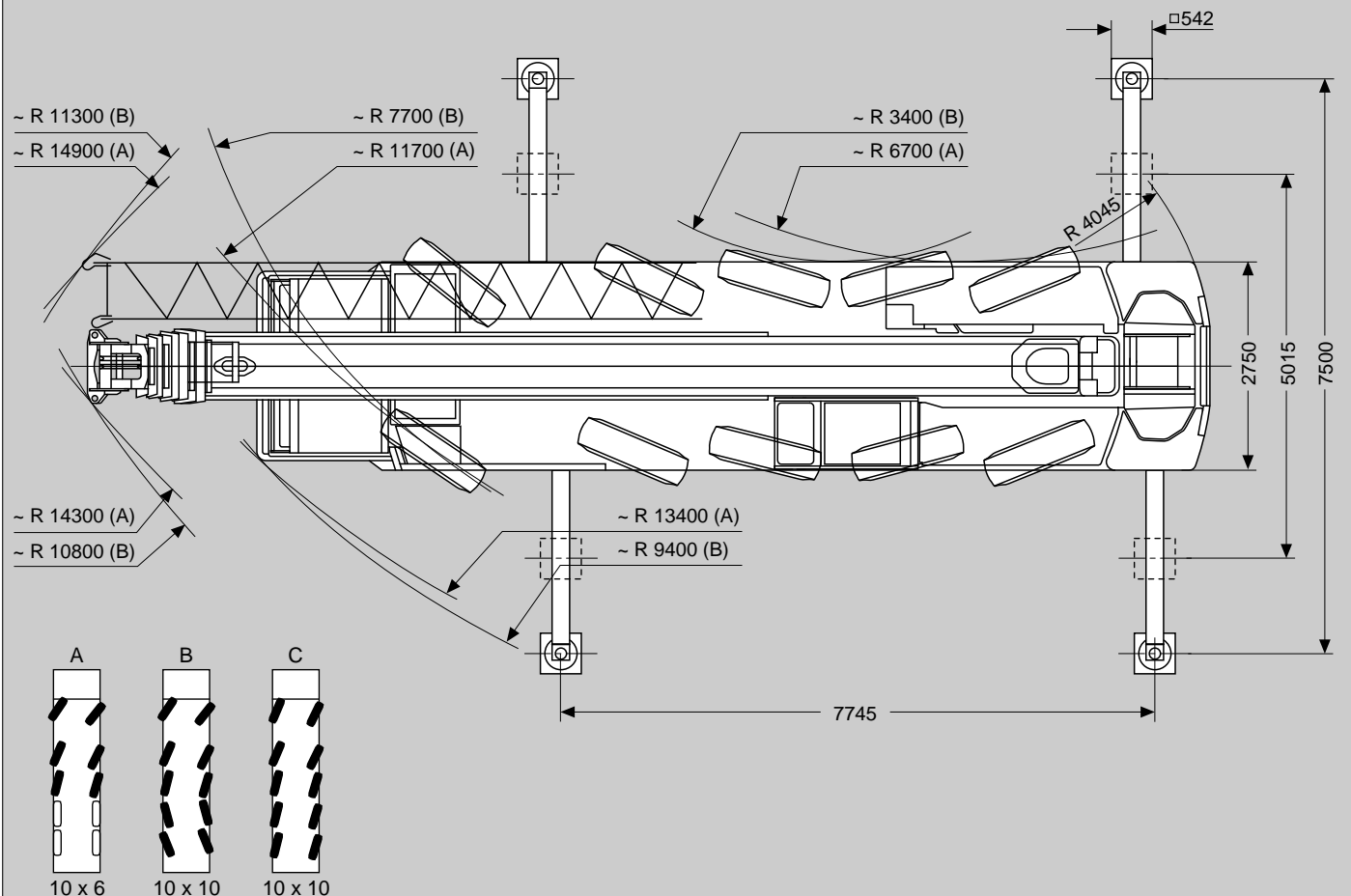

Gewichte / Geschwindigkeiten  
Weights / Working speeds  
Poids / Vitesses  
Pesos / Velocidades de trabajo

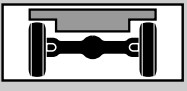
	Achse / Axle Essieu / Eje	1	2	3	4	5	Gesamtgewicht / Total weight Poids total / Peso total
	(t)	12	12	12	12	12	60 <sup>1)</sup>
	(t)	12	12	12	12	12	60 <sup>2)</sup>

1) Incl. 8,2 t Gegengewicht, Bereifung 16.00 R 25, 63 t Hakenflasche, Antrieb 10 x 8.

1) Incl. 8.2 t counterweight, tyres 16.00 R 25, 63 t hook block, drive 10 x 8.

1) Incl. de 8,2 t contrepoids, pneus 16.00 R 25, 63 t moufle, entraînement 10 x 8.

1) Incl. contrapeso de 8,2 t, neumáticos 16.00 R 25, gancho de 63 t, tracción 10 x 8.

2) Incl. 6,4 t Gegengewicht, Bereifung 16.00 R 25, 9,5 m / 16,2 m Gitterspitze, 63 t Hakenflasche, 8 t Hakengeschirr, Antrieb 10 x 8.

2) Incl. 6.4 t counterweight, tyres 16.00 R 25, 9.5 m / 16.2 m folding swingaway, 63 t hook block, 8 t swivel hook, drive 10 x 8.

2) Incl. de 6,4 t contrepoids, pneus 16.00 R 25, 9,5 m / 16,2 m extension treillis, 63 t moufle, 8 t elingues, entraînement 10 x 8.

2) Incl. contrapeso de 6,4 t, neumáticos 16.00 R 25, plumin articulado, gancho de 63 t, 8 t gancho de bola, tracción 10 x 8.

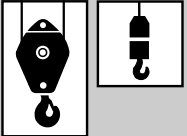
	Traglast / Lifting capacity / Force de levage / Capacidad de elevación	Rollen / Sheaves Pulies / Poleas	Stränge / Parts of line Brins / Ramales de cable	Gewicht / Weight Poid / Peso
	110 t *	7	15	1500 kg
80 t *	5	11	800 kg	
63 t *	3	7	600 kg	
63 t	3	7	600 kg	
25 t	1	3	300 kg	
8 t	-	1	200 kg	





\* Doppelhaken



\* Rams horn

\* Moufle avec crochet marin

\* Gancho doble

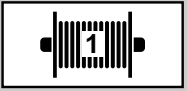
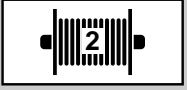

	14.00 R 25							16.00 R 25								
	1	2	3	4	5	6	R	1	2	3	4	5	6	R		
km/h 	0-12	26	37	56	74	80	0-8	31%	0-13	28	40	61	80	80	0-9	28%
km/h 	0-7	15	21	33	43	49	0-5	62%	0-8	16	23	35	47	53	0-5	55%
	14.00 R 25							16.00 R 25								

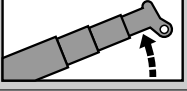
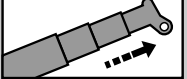
V+ 	Stufenlos Infinitely variable Progressivement variable Infinitamente variable	Seil Rope Câble Cable	Max. Seilzug Max. single line pull Effort maxi au brin simple Trio máximo por ramal
	0 - 128 m/min 4. Lage 4 <sup>th</sup> layer 4 <sup>ème</sup> brin capa 4	für einfachen Strang single line au brin simple ramal simple	21 mm / 250 m 91 kN 1. Lage 1 <sup>st</sup> layer 1 <sup>er</sup> brin capa 1
	0 - 128 m/min 4. Lage 4 <sup>th</sup> layer 4 <sup>ème</sup> brin capa 4	für einfachen Strang single line au brin simple ramal simple	21 mm / 250 m 91 kN 1. Lage 1 <sup>st</sup> layer 1 <sup>er</sup> brin capa 1
	0 - 1.5 min <sup>-1</sup>		
	-2° - +82°	ca. 50 s approx. 50 s env. 50 s aproximadamente 50 s	
	12.8 m - 51.0 m	ca. 140 s approx. 140 s env. 140 s aproximadamente 140 s	

Tragfähigkeiten  
Lifting capacities  
Capacités de levage  
Capacidades de elevación

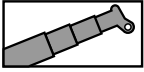

25.0t

DIN/ISO

m	12.8 m*	12.8 m	17.5 m	22.3 m	27.1 m	31.9 m	36.7 m	41.4 m	46.2 m	51.0 m
	3.0	110.0**	95.0	80.0						
3.5	93.8	82.0	78.8	60.0						
4.0	87.5	75.6	74.7	60.0	43.0					
4.5	80.6	70.0	69.1	60.0	43.0					
5.0	72.5	65.1	64.2	60.0	43.0	33.0				
6.0	60.0	57.0	56.2	54.5	43.0	33.0	20.0			
7.0	51.0	50.6	49.7	48.7	43.0	33.0	20.0	20.0		
8.0	44.1	44.1	42.8	42.9	41.2	33.0	20.0	20.0	15.0	13.0
9.0	38.6	38.6	37.4	37.5	36.8	32.0	20.0	20.0	15.0	13.0
10.0	33.8	33.8	32.3	32.5	31.5	30.9	20.0	20.0	15.0	13.0
11.0			27.3	27.5	26.8	26.8	20.0	20.0	15.0	13.0
12.0			23.6	23.8	23.1	23.1	20.0	19.6	15.0	13.0
14.0			17.9	20.0	20.0	20.0	18.5	18.8	14.7	12.8
16.0				16.6	17.0	17.1	14.5	15.2	14.3	12.5
18.0				13.6	13.9	14.2	11.5	12.2	12.8	12.1
20.0					11.6	11.8	9.3	10.8	11.3	10.9
22.0					9.8	10.0	7.5	9.7	9.5	9.1
24.0					8.3	8.5	6.1	8.3	8.0	7.6
26.0						7.3	4.9	7.2	6.9	6.4
28.0						6.3	3.9	6.5	5.9	5.4
30.0							3.0	5.6	5.0	4.5
32.0							2.3	4.8	4.3	3.7
34.0							1.7	4.2	3.6	3.1
36.0								3.6	3.0	2.5
38.0								3.1	2.5	2.0
40.0									2.1	1.6
42.0									1.7	1.2
44.0										0.8
46.0										0.5

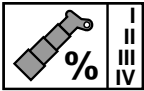

I  
II  
III  
IV

0

50

50/100/0

100/0

50/100/0

100

50/100/0

100

50/100/100

100/50

100

0

50/0/33

50/50

50/100/67

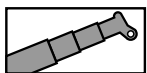

25.0t

DIN/ISO

m	46.2 m + 9.5 m			51.0 m + 9.5 m			51.0 m + 16.2 m			51.0 m + 24.1 m			51.0 m + 30.1 m		
	5°	20°	40°	5°	20°	40°	5°	20°	40°	5°	20°	40°	5°	20°	40°
10.0	9.00			7.00											
11.0	9.00			7.00											
12.0	9.00	7.50		7.00	6.50										
14.0	9.00	7.50	5.20	7.00	6.50		5.00								
16.0	8.75	7.20	5.20	7.00	6.50	5.30	5.00	4.20							
18.0	8.45	6.75	5.00	7.00	6.50	5.15	5.00	4.20					2.30		
20.0	8.20	6.40	4.85	6.85	6.35	4.95	4.90	4.10	3.10	3.30			2.30		
22.0	7.90	6.05	4.70	6.70	6.20	4.80	4.80	4.00	3.00	3.15	2.55		2.30		
24.0	7.55	5.80	4.55	6.55	6.05	4.65	4.70	3.80	2.90	3.05	2.40		2.20	1.85	
26.0	6.30	5.50	4.40	6.35	5.80	4.55	4.60	3.60	2.80	2.90	2.30	1.80	2.10	1.75	
28.0	5.25	5.25	4.30	5.45	5.55	4.40	4.45	3.45	2.70	2.80	2.15	1.70	2.00	1.65	
30.0	4.35	4.70	4.20	4.55	4.95	4.30	4.20	3.30	2.65	2.60	2.05	1.65	1.90	1.55	1.30
32.0	3.60	3.90	4.10	3.80	4.15	4.20	3.95	3.15	2.55	2.40	1.95	1.60	1.75	1.45	1.25
34.0	2.95	3.20	3.45	3.15	3.40	3.70	3.75	3.00	2.50	2.25	1.85	1.55	1.65	1.35	1.20
36.0	2.35	2.60	2.80	2.55	2.80	3.00	3.25	2.90	2.45	2.15	1.75	1.50	1.50	1.30	1.10
38.0	1.85	2.05	2.20	2.00	2.25	2.45	2.75	2.80	2.40	2.00	1.70	1.45	1.40	1.20	1.05
40.0	1.35	1.55	1.65	1.55	1.75	1.90	2.25	2.65	2.30	1.90	1.60	1.40	1.30	1.15	1.00
42.0	0.95	1.10	1.15	1.15	1.30	1.45	1.85	2.20	2.25	1.80	1.55	1.35	1.25	1.10	1.00
44.0	0.55	0.70	0.70	0.75	0.90	1.00	1.45	1.75	2.00	1.70	1.45	1.30	1.15	1.05	0.95
46.0					0.55	0.60	1.10	1.40	1.60	1.55	1.40	1.25	1.10	0.95	0.90
48.0							0.80	1.05	1.20	1.20	1.35	1.20	1.00	0.90	0.85
50.0							0.50	0.70	0.85	0.90	1.30	1.15	0.95	0.85	0.80
52.0									0.50	0.65	1.00	1.10	0.85	0.80	0.75
54.0											0.70	0.95	0.60	0.80	0.70
56.0												0.65		0.75	0.70
58.0														0.50	0.65
60.0															0.65

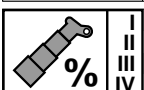

I  
II  
III  
IV

100

100

100

100

100

100

100

100

100

100

100

100

100

100

100

Hubhöhen  
Lifting heights  
Hauteurs de levage  
Alturas de elevación

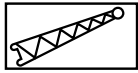
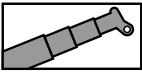

25.0t

DIN/ISO

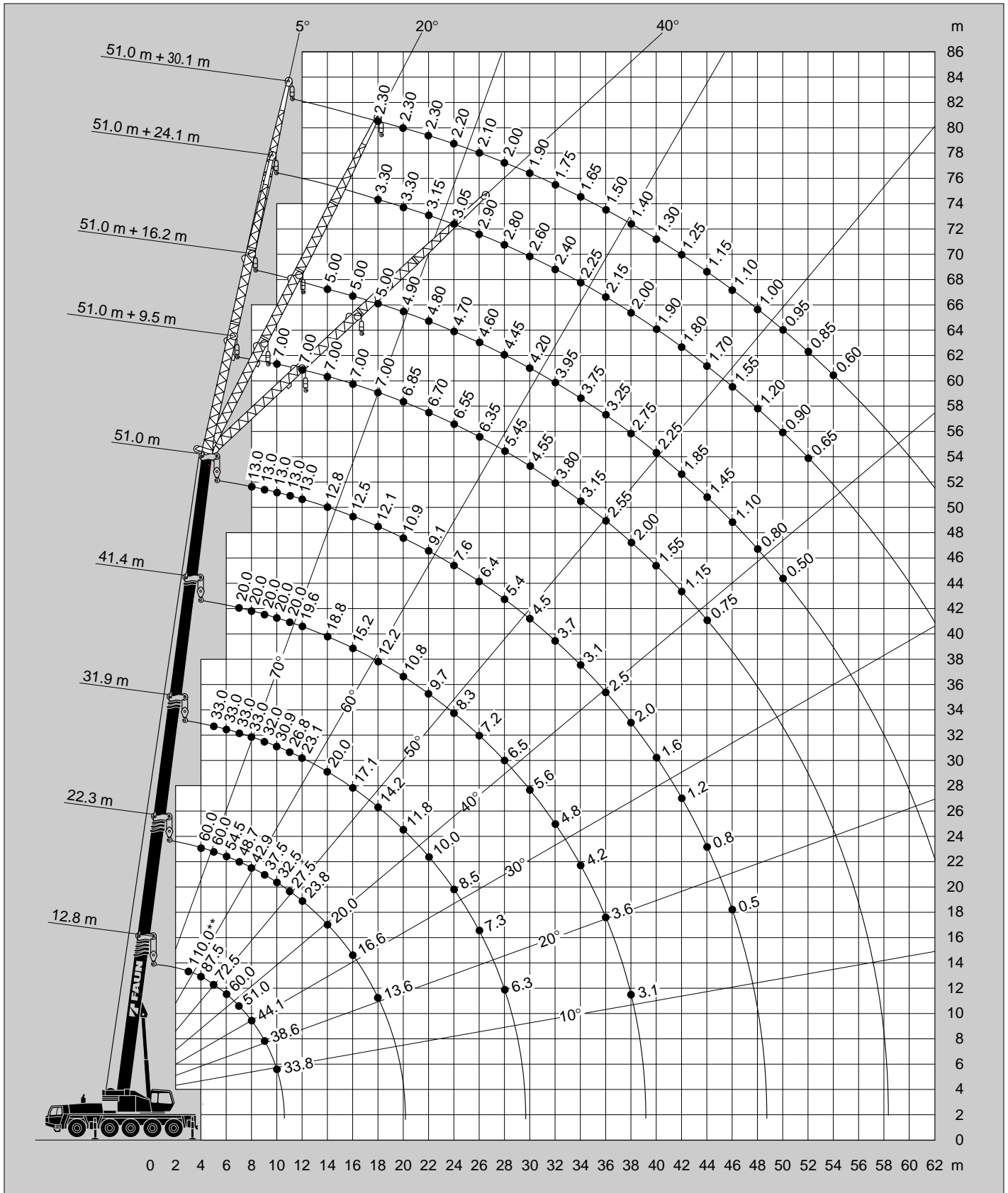

\* Nach hinten

\* Over rear

\* A l'arrière

\* Sobre la parte trasera

\*\* Mit Zusatzhubausrüstung

\*\* With additional equipment

\*\* Avec équipement supplémentaire

\*\* Con equipo adicional

Tragfähigkeiten  
Lifting capacities  
Capacités de levage  
Capacidades de elevación

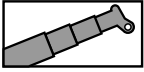

14.0t

DIN/ISO

↗ m	12.8 m*	12.8 m	17.5 m	22.3 m	27.1 m	31.9 m	36.7 m	41.4 m	46.2 m	51.0 m
3.0	110.0**	95.0	80.0							
3.5	93.8	81.2	78.8	60.0						
4.0	83.3	74.8	74.0	60.0	43.0					
4.5	74.0	69.3	68.5	60.0	43.0					
5.0	66.5	64.5	63.7	60.0	43.0	33.0				
6.0	55.0	55.0	53.7	52.9	43.0	33.0	20.0			
7.0	46.7	46.7	45.4	45.4	43.0	33.0	20.0	20.0		
8.0	38.9	38.9	37.2	37.4	36.4	33.0	20.0	20.0	15.0	13.0
9.0	31.3	31.3	29.8	30.0	29.2	29.4	20.0	20.0	15.0	13.0
10.0	26.0	26.0	24.5	24.7	23.9	24.1	20.0	20.0	15.0	13.0
11.0			20.5	20.7	20.0	20.1	20.0	20.0	15.0	13.0
12.0			17.5	20.0	20.0	20.0	18.2	18.9	15.0	13.0
14.0			12.9	15.7	16.1	16.4	13.5	15.5	14.7	12.8
16.0				12.4	12.7	13.0	10.3	12.8	12.5	12.0
18.0				9.9	10.2	10.5	7.8	10.7	10.1	9.5
20.0					8.3	8.5	5.9	8.8	8.1	7.6
22.0					6.8	7.0	4.4	7.3	6.6	6.0
24.0					5.5	5.8	3.3	6.0	5.4	4.8
26.0						4.7	2.3	5.0	4.4	3.8
28.0						3.9	1.5	4.2	3.5	3.0
30.0							0.8	3.4	2.8	2.3
32.0								2.8	2.2	1.7
34.0								2.3	1.7	1.2
36.0								1.8	1.2	0.7
38.0								1.4	0.8	
40.0										
42.0										
44.0										
46.0										

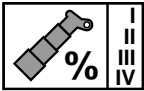

I  
II  
III  
IV

0

50

50/100/0

100/0

50/100/0

100

50/100/0

100

50/100/100

100/50

100

0

0

0/0/33

0/50

50/0/67

25

100/50/100

75/100

100

0

0

0/0/33

0/50

50/0/67

25

100/50/100

75/100

100

100

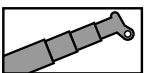

14.0t

DIN/ISO

↗ m	46.2 m + 9.5 m			51.0 m + 9.5 m			51.0 m + 16.2 m			51.0 m + 24.1 m			51.0 m + 30.1 m		
	5°	20°	40°	5°	20°	40°	5°	20°	40°	5°	20°	40°	5°	20°	40°
10.0	9.00			7.00											
11.0	9.00			7.00											
12.0	9.00	7.50		7.00	6.50										
14.0	9.00	7.50	5.20	7.00	6.50		5.00								
16.0	8.75	7.20	5.20	7.00	6.50	5.30	5.00	4.20							
18.0	8.45	6.75	5.00	7.00	6.50	5.15	5.00	4.20					3.30		2.30
20.0	7.65	6.40	4.85	6.85	6.35	4.95	4.90	4.10	3.10	3.30			2.30		2.30
22.0	6.10	6.05	4.70	6.30	6.20	4.80	4.80	4.00	3.00	3.15	2.55		2.30		2.30
24.0	4.80	5.35	4.55	5.05	5.55	4.65	4.70	3.80	2.90	3.05	2.40		2.20	1.85	
26.0	3.80	4.25	4.40	4.00	4.45	4.55	4.60	3.60	2.80	2.90	2.30	1.80	2.10	1.75	
28.0	2.90	3.35	3.75	3.15	3.55	3.95	3.95	3.45	2.70	2.80	2.15	1.70	2.00	1.65	
30.0	2.20	2.55	2.90	2.40	2.75	3.10	3.20	3.30	2.65	2.60	2.05	1.65	1.90	1.55	1.30
32.0	1.55	1.85	2.15	1.75	2.10	2.40	2.55	3.10	2.55	2.40	1.95	1.60	1.75	1.45	1.25
34.0	1.00	1.30	1.55	1.20	1.50	1.75	1.95	2.50	2.50	2.25	1.85	1.55	1.65	1.35	1.20
36.0	0.55	0.75	0.95	0.75	1.00	1.20	1.45	1.95	2.40	1.95	1.75	1.50	1.50	1.30	1.10
38.0			0.50		0.55	0.75	1.05	1.45	1.85	1.50	1.70	1.45	1.40	1.20	1.05
40.0							0.65	1.05	1.40	1.10	1.60	1.40	1.30	1.15	1.00
42.0								0.65	0.95	0.75	1.30	1.35	1.00	1.10	1.00
44.0									0.55		0.95	1.30	0.65	1.05	0.95
46.0											0.60	1.05		0.95	0.90
48.0												0.70		0.65	0.85
50.0															0.80
52.0															0.60
54.0															
56.0															
58.0															
60.0															

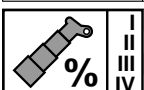

I  
II  
III  
IV

100

100

100

100

100

100

100

100

100

100

100

100

100

100

100

Hubhöhen  
Lifting heights  
Hauteurs de levage  
Alturas de elevación

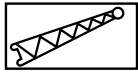
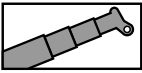

14.0t

DIN/ISO

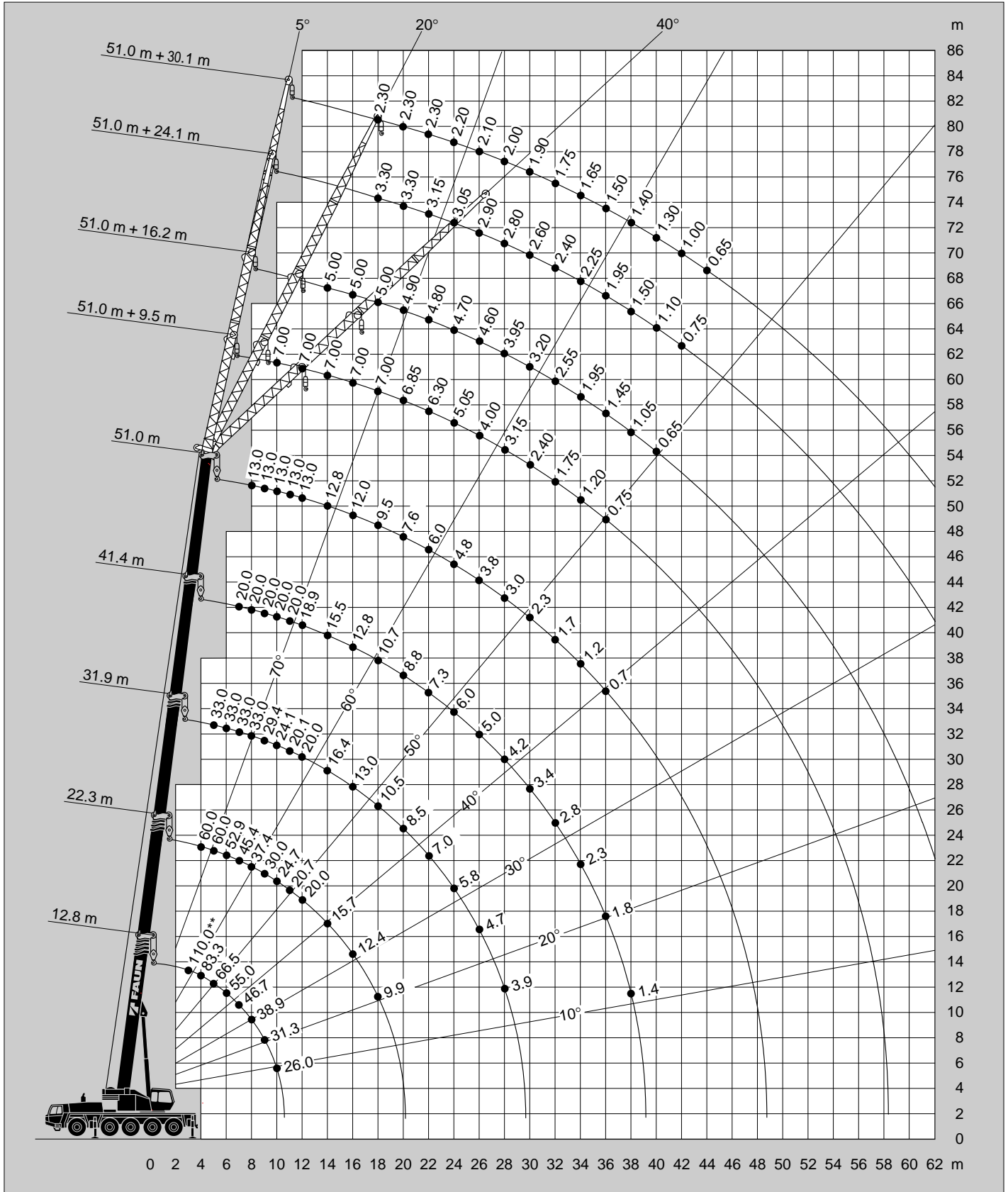

\* Nach hinten

\* Over rear

\* A l'arrière

\* Sobre la parte trasera

\*\* Mit Zusatzhubausrüstung

\*\* With additional equipment

\*\* Avec équipement supplémentaire

\*\* Con equipo adicional

Tragfähigkeiten  
Lifting capacities  
Capacités de levage  
Capacidades de elevación

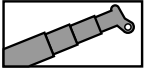

8.2t

DIN/ISO

↗ m	12.8 m*	12.8 m	17.5 m	22.3 m	27.1 m	31.9 m	36.7 m	41.4 m	46.2 m	51.0 m
3.0	100.0**	90.0	80.0							
3.5	90.5	80.8	78.8	60.0						
4.0	79.4	74.5	73.6	60.0	43.0					
4.5	70.6	69.0	68.1	60.0	43.0					
5.0	63.4	63.4	62.0	60.0	43.0	33.0				
6.0	52.4	52.4	51.1	50.2	43.0	33.0	20.0			
7.0	43.0	43.0	41.1	41.4	40.4	33.0	20.0	20.0		
8.0	33.1	33.1	31.4	31.7	30.8	31.1	20.0	20.0	15.0	13.0
9.0	26.5	26.5	25.0	25.2	24.4	24.6	20.0	20.0	15.0	13.0
10.0	21.8	21.8	20.3	20.5	20.0	20.0	20.0	20.0	15.0	13.0
11.0			16.9	20.0	20.0	20.0	17.6	18.4	15.0	13.0
12.0			14.2	17.2	17.6	17.9	14.9	16.2	15.0	13.0
14.0			10.0	13.0	13.4	13.6	10.6	14.0	13.2	12.5
16.0				9.9	10.3	10.5	7.7	10.9	10.1	9.5
18.0				7.7	8.0	8.3	5.6	8.6	7.9	7.3
20.0					6.3	6.6	3.9	6.9	6.2	5.6
22.0					5.0	5.2	2.7	5.5	4.8	4.3
24.0					4.0	4.2	1.7	4.5	3.8	3.2
26.0						3.3	0.9	3.6	2.9	2.4
28.0						2.6		2.9	2.2	1.7
30.0								2.2	1.6	1.1
32.0								1.7	1.1	0.6
34.0								1.2	0.6	
36.0								0.8		
38.0								0.5		
40.0										
42.0										
44.0										
46.0										

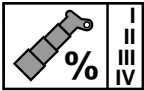

I	0	50	50/100/0	100/0	50/100/0	100	50/100/0	100/50	100
II	0	0	50/0/33	50/50	50/100/67	100	50/100/100	100/100	100
III	0	0	0/0/33	0/50	50/0/67	25	100/50/100	75/100	100
IV	0	0	0/0/33	0/50	50/0/67	25	100/50/100	75/100	100

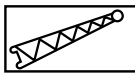
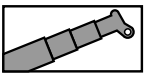

8.2t

DIN/ISO

↗ m	46.2 m + 9.5 m			51.0 m + 9.5 m			51.0 m + 16.2 m			51.0 m + 24.1 m			51.0 m + 30.1 m		
	5°	20°	40°	5°	20°	40°	5°	20°	40°	5°	20°	40°	5°	20°	40°
10.0	9.00			7.00											
11.0	9.00			7.00											
12.0	9.00	7.50		7.00	6.50										
14.0	9.00	7.50	5.20	7.00	6.50	5.30	5.00	4.20							
16.0	8.75	7.20	5.20	7.00	6.50	5.30	5.00	4.20							
18.0	7.50	6.75	5.00	7.00	6.50	5.15	5.00	4.20					2.30		
20.0	5.75	6.40	4.85	5.95	6.35	4.95	4.90	4.10	3.10	3.30			2.30		
22.0	4.40	5.00	4.70	4.60	5.20	4.80	4.80	4.00	3.00	3.15	2.55		2.30		
24.0	3.30	3.80	4.35	3.50	4.05	4.60	4.35	3.80	2.90	3.05	2.40		2.20	1.85	
26.0	2.40	2.85	3.30	2.60	3.05	3.55	3.40	3.60	2.80	2.90	2.30	1.80	2.10	1.75	
28.0	1.65	2.05	2.45	1.85	2.25	2.70	2.65	3.35	2.70	2.80	2.15	1.70	2.00	1.65	
30.0	1.00	1.35	1.70	1.20	1.60	1.95	2.00	2.60	2.65	2.50	2.05	1.65	1.90	1.55	1.30
32.0		0.75	1.05	0.65	1.00	1.30	1.45	2.00	2.55	1.95	1.95	1.60	1.75	1.45	1.25
34.0			0.50		0.50	0.75	0.95	1.45	2.00	1.45	1.85	1.55	1.65	1.35	1.20
36.0							0.50	0.95	1.45	1.00	1.70	1.50	1.25	1.30	1.10
38.0								0.55	0.95	0.60	1.25	1.45	0.85	1.20	1.05
40.0									0.55		0.85	1.40	0.50	1.15	1.00
42.0											0.50	1.05		0.90	1.00
44.0												0.70		0.55	0.95
46.0															0.90
48.0															0.55
50.0															
52.0															
54.0															
56.0															
58.0															
60.0															

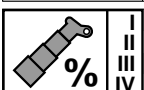

I	100	100	100	100	100	100	100	100	100
II	100	100	100	100	100	100	100	100	100
III	75	100	100	100	100	100	100	100	100
IV	75	100	100	100	100	100	100	100	100



Hubhöhen  
Lifting heights  
Hauteurs de levage  
Alturas de elevación

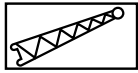
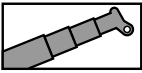

8.2t

DIN/ISO

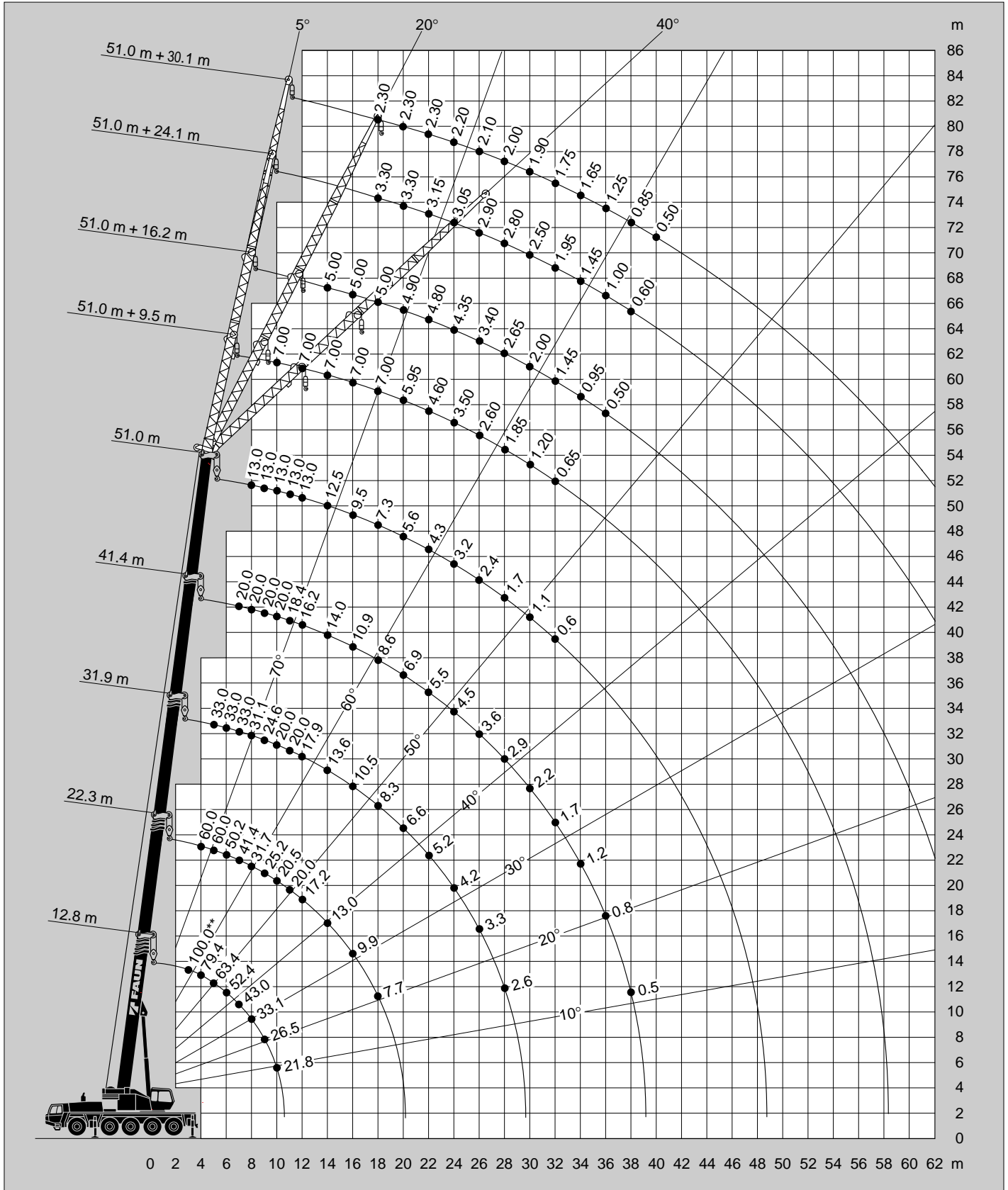

\* Nach hinten

\* Over rear

\* A l'arrière

\* Sobre la parte trasera

\*\* Mit Zusatzhubausrüstung

\*\* With additional equipment

\*\* Avec équipement supplémentaire

\*\* Con equipo adicional

Tragfähigkeiten  
Lifting capacities  
Capacités de levage  
Capacidades de elevación

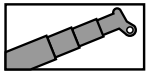

6.4t

DIN/ISO

m	12.8 m*	12.8 m	17.5 m	22.3 m	27.1 m	31.9 m	36.7 m	41.4 m	46.2 m	51.0 m
	3.0	100.0**	90.0	80.0						
3.5	89.1	80.7	78.8	60.0						
4.0	78.2	74.4	73.5	60.0	43.0					
4.5	69.5	68.9	68.0	60.0	43.0					
5.0	62.4	62.4	61.0	60.0	43.0	33.0				
6.0	51.6	51.6	50.2	49.4	43.0	33.0	20.0			
7.0	40.8	40.8	38.9	39.2	38.1	33.0	20.0	20.0		
8.0	31.3	31.3	29.7	29.9	29.0	29.3	20.0	20.0	15.0	13.0
9.0	25.0	25.0	23.5	23.7	22.9	23.1	20.0	20.0	15.0	13.0
10.0	20.6	20.6	19.1	20.0	20.0	20.0	19.8	20.0	15.0	13.0
11.0			15.7	18.9	19.3	19.6	16.4	17.3	15.0	13.0
12.0			13.0	16.2	16.6	16.9	13.8	16.2	15.0	13.0
14.0			9.0	12.0	12.4	12.7	9.7	13.0	12.2	11.6
16.0				9.1	9.5	9.7	6.9	10.1	9.3	8.7
18.0				7.0	7.3	7.6	4.9	7.9	7.2	6.6
20.0					5.7	6.0	3.3	6.3	5.6	5.0
22.0					4.5	4.7	2.2	5.0	4.3	3.8
24.0					3.5	3.7	1.2	4.0	3.3	2.8
26.0						2.9		3.2	2.5	2.0
28.0						2.2		2.5	1.8	1.3
30.0								1.9	1.2	0.7
32.0								1.4	0.7	
34.0								0.9		
36.0								0.5		
38.0										
40.0										
42.0										
44.0										
46.0										

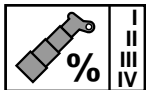

I	0	50	50/100/0	100/0	50/100/0	100	50/100/0	100/50	100
II	0	0	50/0/33	50/50	50/100/67	100	50/100/100	100/100	100
III	0	0	0/0/33	0/50	50/0/67	25	100/50/100	75/100	100
IV	0	0	0/0/33	0/50	50/0/67	25	100/50/100	75/100	100

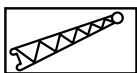
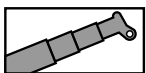

6.4t

DIN/ISO

m	46.2 m + 9.5 m			51.0 m + 9.5 m			51.0 m + 16.2 m			51.0 m + 24.1 m			51.0 m + 30.1 m		
	5°	20°	40°	5°	20°	40°	5°	20°	40°	5°	20°	40°	5°	20°	40°
10.0	9.00			7.00											
11.0	9.00			7.00											
12.0	9.00	7.50		7.00	6.50										
14.0	9.00	7.50	5.20	7.00	6.50	5.30	5.00	4.20							
16.0	8.75	7.20	5.20	7.00	6.50	5.30	5.00	4.20							
18.0	6.75	6.75	5.00	7.00	6.50	5.15	5.00	4.20				3.30			2.30
20.0	5.15	5.80	4.85	5.35	6.05	4.95	4.90	4.10	3.10	3.30					2.30
22.0	3.85	4.45	4.70	4.05	4.65	4.80	4.80	4.00	3.00	3.15	2.55				2.30
24.0	2.80	3.30	3.85	3.00	3.50	4.10	3.85	3.80	2.90	3.05	2.40			2.20	1.85
26.0	1.95	2.40	2.85	2.15	2.60	3.10	2.95	3.60	2.80	2.90	2.30	1.80		2.10	1.75
28.0	1.20	1.60	2.05	1.40	1.85	2.25	2.25	2.90	2.70	2.75	2.15	1.70		2.00	1.65
30.0	0.60	1.00	1.30	0.80	1.20	1.55	1.60	2.25	2.65	2.15	2.05	1.65		1.90	1.55
32.0			0.70		0.65	0.95	1.05	1.65	2.25	1.60	1.95	1.60		1.75	1.45
34.0							0.60	1.10	1.65	1.10	1.85	1.55		1.35	1.35
36.0								0.65	1.15	0.70	1.40	1.50		0.95	1.30
38.0									0.65		0.95	1.45		0.55	1.20
40.0											0.55	1.20		0.95	1.00
42.0												0.80		0.60	1.00
44.0															0.95
46.0															0.65
48.0															
50.0															
52.0															
54.0															
56.0															
58.0															
60.0															

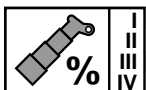

I	100	100	100	100	100	100	100	100	100
II	100	100	100	100	100	100	100	100	100
III	75	100	100	100	100	100	100	100	100
IV	75	100	100	100	100	100	100	100	100

Hubhöhen  
Lifting heights  
Hauteurs de levage  
Alturas de elevación

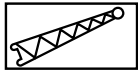
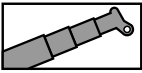

6.4t

DIN/ISO

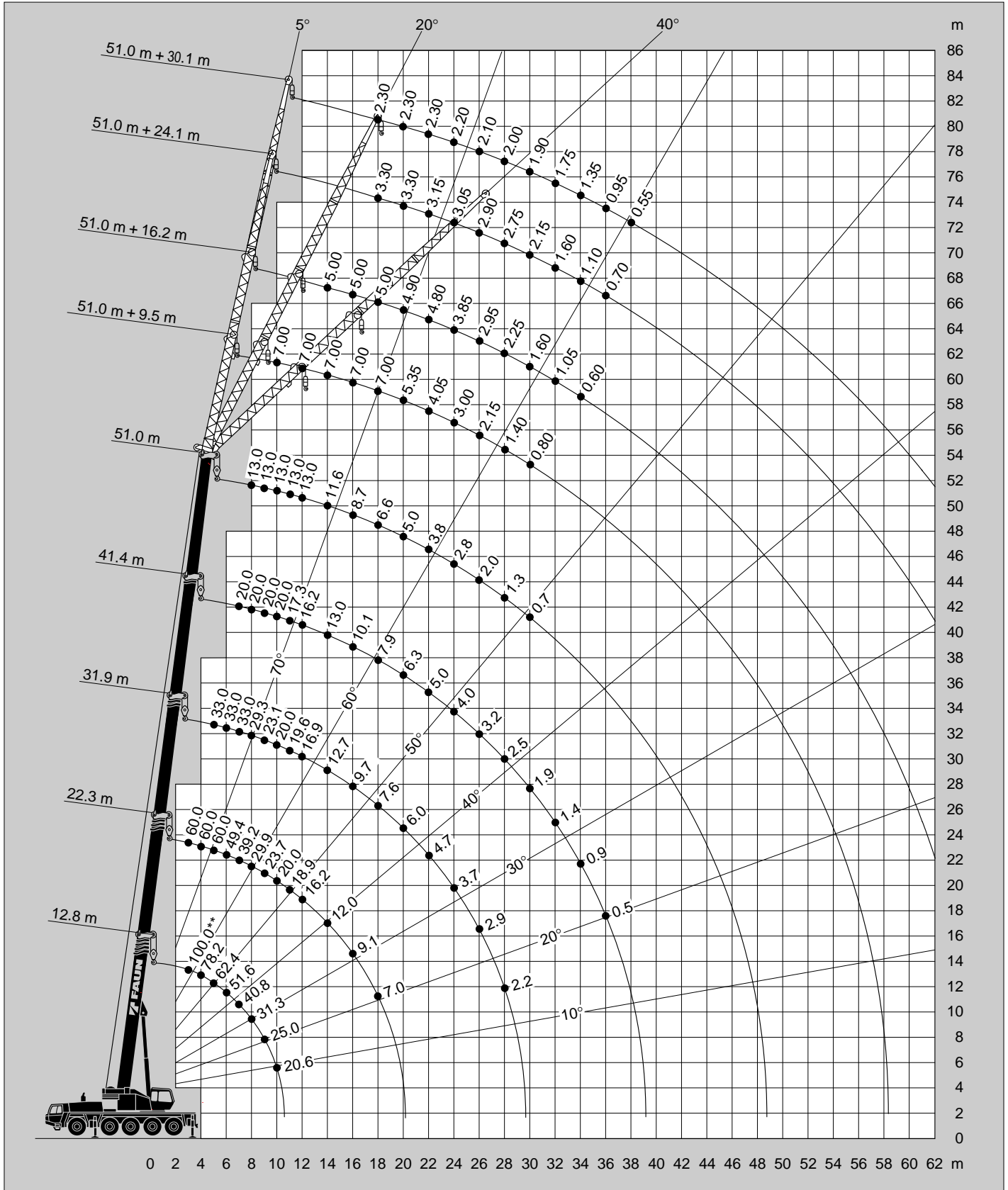

\* Nach hinten

\* Over rear

\* A l'arrière

\* Sobre la parte trasera

\*\* Mit Zusatzhubausrüstung

\*\* With additional equipment

\*\* Avec équipement supplémentaire

\*\* Con equipo adicional

**Anmerkungen zu den Traglasttabellen**

Die Tragfähigkeiten im Festigkeitsbereich basieren auf DIN 15018 Blatt 2 und Blatt 3 und F.E.M.

Die Tragfähigkeiten im Standsicherheitsbereich entsprechen DIN 15019 Teil 2 / ISO 4305.

Die zulässige Windgeschwindigkeit beträgt maximal 10 m/sec.

Die Tragfähigkeiten sind in metrischen Tonnen angegeben.

Das Gewicht des Lasthakens bzw. der Hakenflasche und weiterer Anschlagmittel ist von der Tragfähigkeit abzuziehen.

Die Tragfähigkeiten für den Teleskopausleger gelten nur bei demonstrierter Spitze.

Die Ausladung ist der horizontale Abstand von Mitte Drehkranz bis Mitte freihängender, nicht schwingender Last.

Tragfähigkeitsänderungen vorbehalten.

Obige Angaben dienen nur zur Information. Die Bedienungsanleitungen müssen zu Rate gezogen werden, bevor die Maschine in Betrieb genommen wird. Alle hier gemachten Angaben beziehen sich auf die Standard-Ausführung. Jegliche Ausrüstungsveränderungen können die angegebenen Werte beeinflussen.

**Remarks relating to the rating charts**

The lifting capacities in the structural area are based on DIN 15018 parts 2 and 3 and F.E.M.

The lifting capacities in the stability area are based on DIN 15019 part 2 / ISO 4305.

The maximum permissible wind speed for crane operation is 10 m/sec.

The lifting capacities shown are in metric tons.

The weight of load handling devices such as hook blocks, slings, etc., must be considered as part of the load and must be deducted from the lifting capacities.

The lifting capacities for the telescopic boom apply to a crane with no boom extensions being stowed or mounted on the crane.

The working radius is the horizontal distance from the centre of rotation to the centre of the freely suspended non-oscillating load.

The lifting capacities are subject to change without prior notice.

The above remarks are for basic information only and the operator's manual must be consulted before operating this crane. All data and performances refer to the standard crane. The addition of optional and other equipment may affect the performance of the crane.

**Remarques relatives aux tableaux des charges**

Les forces de levage sont conformes aux normes DIN 15018, p. 2 et 3, et F.E.M.

Les forces de levage dans la partie de stabilité au renversement sont conformes aux normes DIN 15019, chap. 2 / ISO 4305.

La grue peut travailler aux vitesses de vent allant jusqu'à 10 m/s.

Les forces de levage sont données en tonnes métriques.

Le poids du crochet-moufle et de tous les accessoires d'élingage font partie de la charge et sont à déduire des charges indiquées.

Les forces de levage indiquées pour la flèche télescopique s'entendent flèche déposée.

Comme portée, on entend la distance horizontale du centre de la couronne de rotation au centre de la charge librement suspendue et non oscillante.

Sauf modification de forces de levage.

Les données ci-dessus servent à titre d'information. Avant la mise en marche de la grue il est conseillé d'étudier les instructions de service. Toutes les données indiquées ci-dessus se réfèrent à la machine de base. Tout changement de l'équipement de la grue peut influencer ces valeurs.

**Notas relativas a los gráficos de carga**

En cuanto a los datos referentes a resistencia, las capacidades de carga están basados sobre las normas DIN 15018, pág. 2 y 3, y F.E.M.

En cuanto a los datos referentes a estabilidad anti-vuelco, las capacidades de carga están basados sobre las normas DIN 15019, Cap. 2 / ISO 4305.

La velocidad anemométrica max. admisible es de 10 m/seg.

Las capacidades de carga indicadas en las tablas corresponden a toneladas métricas.

Hay que deducir los pesos del gancho o del motón y de otros dispositivos para fijación de cargas de los valores de capacidad de carga indicados en las tablas.

Las capacidades de carga referentes a la pluma telescópica rigen solamente si la punta está desmontada.

Como alcance se entiende la distancia horizontal desde el centro de la corona de rodaduras hasta el centro de la carga suspendida libremente y no oscilante.

Salvo modificación de capacidades de carga.

Los datos arriba indicados sirven solamente para su información. Hay que leer las instrucciones para el uso antes de la puesta en servicio de la máquina. Todos los datos mencionados en las presentes tablas rigen para los modelos standard. Cualquier modificación del equipo montado puede dar lugar a modificaciones de aquellos valores.

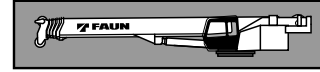
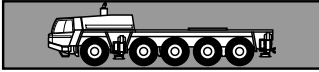

**Rahmen** Verwindungs- und biegesteife Schweißkonstruktion aus hochfestem Feinkornstahl.

**Abstützung** 4-Punkt-Abstützung, hydraulisch, Bedienungsmöglichkeiten an beiden Seiten des Fahrgestelles, automatische Nivellierung. Abstützbasis 7,5 m (und 5,0 m) x 7,74 m.

**Motor** Mercedes-Benz 8-Zylinder-Dieselmotor OM 502 LA (Euromot 2/EPA 2), wassergekühlt, Leistung 350 kW (476 PS) bei 2000 min<sup>-1</sup>. Drehmoment 2100 Nm (214 kpm) bei 1080 min<sup>-1</sup>.

**Getriebe** Allison-Automatgetriebe HD 4560 P mit hydrodynamischem Drehmomentwandler mit "Lock-up" mit 6 Vorwärts- und 1 Rückwärtsgang. Zweistufiges Verteilergetriebe Steyr VG 1600 mit Straßen- und Geländegang.

**Antrieb** 10 x 6

#### Achsen

1. Achse: gelenkt, nicht angetrieben.
  2. Achse: gelenkt, nicht angetrieben.
  3. Achse: gelenkt, angetrieben.
  4. Achse: gelenkt, angetrieben.
  5. Achse: gelenkt, angetrieben.
- Quersperren in allen Antriebsachsen.

**Achsaufhängung** Hydropneumatische Federung mit Niveauregulierung.

**Bremsen** Druckluft-Zweikreis-Bremsanlage. Feststellbremse als Federspeicherbremse an der 3., 4. und 5. Achse wirkend. Dauerbremse als Konstantdrosselanlage mit Auspuffklappenbremse.

**Räder** 10-fach 14.00 R 25

**Lenkung** ZF-Halblock-Zweikreishydraulenlenkung. Mechanische Lenkung der 1., 2. und 3. Achse, hydraulisch unterstützt, mit Notlenkpumpe. Lenkung aller Achsen möglich.

**Unterbaukabine** Zwei-Mann-Frontfahrerhaus in Stahl-Kunststoff-Verbund-Konstruktion, Sicherheitsverglasung, luftgedeferte Sitze und motorabhängige Warmwasserheizung, Kontroll- und Bedienungselemente und graphische LCD-Anzeige für den Fahrbetrieb.

**Elektrische Anlage** 24 Volt-Gleichstrom, 2 Batterien. Verdrahtung mit CAN-Bus-Komponenten, integrierte Eigen-diagnose Faun-CSS-System. Die elektrische Anlage entspricht der EG-Norm.

**Zusatzrüstung** (gegen Mehrpreis) Anhängerkupplung, Zusatzheizung, Motorvorwärmung, Klimaanlage, 10 x 8 Antrieb, Wirbelstrombremse, Stützkraftanzeige und -überwachung, 16.00 R 25 Bereifung, 20.5 R 25 Bereifung, Reserverad, Sonderlackierung und Beschriftung. Weitere Zusatzrüstung auf Anfrage.

**Rahmen** Verwindungssteife Schweißkonstruktion mit einer außenverzahnten, einreihigen Kugeldrehverbindung, um 360° unbegrenzt drehbar.

**Motor** Mercedes-Benz 4-Zylinder-Dieselmotor OM 904 LA (Euromot 2/EPA 2), wassergekühlt. Leistung 125 kW (170 PS) bei 2300 min<sup>-1</sup>. Drehmoment 660 Nm (67 kpm) bei 1200 min<sup>-1</sup> (Motorleistung nach DIN 6270B/DIN 6271).

**Hydraulik System** Diesel-hydraulisch mit 3-Kreis-Hydraulik, 1 leistungsgeregelte Axialkolbendoppelpumpe (elektrisch verstellbar und "Cross-Sensing") und 1 Zahnrad-Doppelpumpe.

**Steuerung** Zwei 4-fach Kreuzsteuerhebel mit elektrischer Vorsteuerung.

**Teleskopausleger** Fünfteiliger, kastenförmiger Teleskopausleger, bestehend aus einem Grundausleger und 4 Teleskopteilen, hydraulisch unter Teillast teleskopierbar. 12,8 m - 51,0 m lang.

**Wippwerk** Ein Differentialzylinder mit angebaute Senkbremssperrventil.

**Hubwerk** Axialkolben-Konstant-Motor, Hubwerkstrommel mit eingebautem Planetengetriebe und federbelasteter Hydro-Lamellenbremse mit integriertem Freilauf beim Heben. Hubseil mit "Superstop"-Einrichtung.

**Drehwerk** Konstant-Motor, dreistufiges Planetengetriebe mit fußbetätigter oder automatischer Betriebsbremse und Feststellung. Drehgeschwindigkeit stufenlos von 0 - 1,5 min<sup>-1</sup>.

**Gegengewicht** Gesamtgewicht 8,2 t teilbar. Die Bedienung erfolgt aus der Oberwagenkabine.

**Oberwagenkabine** Großräumige, um 20° kippbare Krankabine in Stahlblechausführung mit Sicherheitsverglasung mit getönten Scheiben, verstellbarem, hydraulisch gedämpftem Fahrersitz, motorabhängige und motorunabhängige Warmwasserheizung (mit Motor-Vorwärmung), Kontroll- und Bedienungselemente und graphische LCD-Anzeige für Kranbetrieb.

**Elektrische Anlage** 24 Volt-Gleichstrom, 2 Batterien.

**Sicherheitseinrichtungen** Lastmomentbegrenzung (LMB) PAT-PDC-System, Hubendschalter, Windenendschalter, Seilwindendrehmelder, Sicherheitsventile gegen Rohr- und Schlauchbrüche. Sperrventile an Hydraulik-Zylindern.

**Zusatzrüstung** (gegen Mehrpreis) Auslegerverlängerung 9,5 m - 16,2 m, Stinger 7,5 m, Zwischenstück 6 m (maximale Länge 30,1 m) in Gitterkonstruktion und alle abwinkelbar (5°, 20° und 40°), Zusatzgegengewicht max. 16,8 t, verschiedene Hakenflaschen, 2. Hubwerk (Seilzug 91 kN 1. Lage), Verfahrbarkeit (incl. Abstützbetätigung) oder nur Abstützbetätigung aus der Oberwagenkabine, Stützkraftanzeige- und -überwachung, Klimaanlage, Sonderlackierung und Beschriftung. Weitere Zusatzrüstung auf Anfrage.

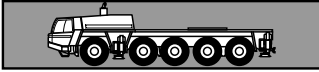

**Frame** Torsion resistant, welded construction made from high strength, fine-grained steel.

**Outriggers** 4 point, double telescopic hydraulic outriggers with controls on both sides of carrier with automatic levelling. Outrigger base 7.5 m (and 5.0 m) x 7.74 m.

**Carrier engine** Mercedes-Benz 8 cylinder model OM 502 LA (Euromot 2/EPA 2), water-cooled diesel engine. Rated at 350 kW (476 HP) at 2000 min<sup>-1</sup>. Torque 2100 Nm (214 kpm) at 1080 min<sup>-1</sup>.

**Transmission** Allison automatic transmission HD 4560 P with hydro-dynamic torque converter with "lock-up" and with 6 forward gears and 1 reverse gear. Two-stage transfer case Steyr VG 1600 with on/off-road range.

**Drive** 10 x 6

#### Axles

1<sup>st</sup> axle: steered.

2<sup>nd</sup> axle: steered.

3<sup>rd</sup> axle: steered, driven.

4<sup>th</sup> axle: steered, driven.

5<sup>th</sup> axle: steered, driven.

All driven axles with differential locks.

**Suspension** Hydro-pneumatic with levelling adjustment.

**Brake system** Service brakes: dual circuit compressed air system. Parking brake: spring loaded type acting on 3<sup>rd</sup>, 4<sup>th</sup> and 5<sup>th</sup> axles. Auxiliary brakes: engine exhaust brake and constant throttle engine brake system.

**Tyres** (10) 14.00 R 25.

**Steering system** From carrier cab: ZF semi-block dual circuit hydraulic steering, mechanical hydraulically-assisted steering of front three axles and emergency steering pump. Steering of all axles possible.

**Carrier cab** Two man full width cab of composite (steel sheet metal and fibre-glass) structure, with safety glass, air-cushioned adjustable seats, engine dependent hot-water heater. Complete controls and instrumentation for road travel and LCD graphic display/controls for carrier operation.

**Electrical system** 24 volt DC system, 2 batteries, CAN-Bus system with Faun CSS integrated self-diagnosis system. Electrical system conforms with EEC regulations.

**Optional Equipment** (at extra charge) Towing attachment, additional heater, engine pre-heat, air conditioning, 10 x 8 drive, eddy current retarder brake, outrigger load display with monitoring, 16.00 R 25 tyres, 20.5 R 25 tyres, spare wheel and tyre, special painting and lettering. Further optional equipment available upon request.

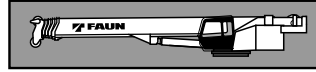

**Frame** Torsion-resistant, all-welded structure of high strength steel. Connected to carrier by single-row ball-bearing slewing ring with external gearing for 360° continuous rotation.

**Superstructure engine** Mercedes-Benz 4 cylinder model OM 904 LA (Euromot 2/EPA 2), water cooled, diesel engine. Rated at 125 kW (170 HP) at 2300 min<sup>-1</sup>. Torque 660 Nm (67 kpm) at 1200 min<sup>-1</sup>. (engine rating according to DIN 6270B/DIN 6271).

**Hydraulic system** Three circuit diesel hydraulic system with 1 double axial piston variable displacement pump (electrically adjustable and "Cross Sensing") and 1 double gear pump.

**Controls** Electrical, 2 joy-stick levers for simultaneous operation of crane motions.

**Telescopic boom** 5 section box type construction of high tensile, fine-grained steel, consisting of 1 base section and 4 telescoping sections. All telescope sections extendable under partial load. 12.8 m to 51.0 m long.

**Derricking system** 1 double acting hydraulic cylinder with integral brake and holding valve.

**Main winch** Axial piston constant displacement motor, winch drum with integrated planetary reduction and with hydraulically controlled spring-loaded, multiple disc brake and with integrated free rotation (no sagging of load when hoisting). Hoist cable with "Superstop" easy reeving system.

**Slewing system** Constant displacement motor with three-stage planetary reduction with a foot actuated or automatic service and a parking brake. Speed infinitely variable 0 - 1.5 min<sup>-1</sup>.

**Counterweight** Standard 8.2 t divisible, assembled and disassembled by hydraulic cylinders controlled from superstructure cab.

**Superstructure cab** Spacious all-steel panoramic cab with safety (tinted) glass windows, hydraulically cushioned adjustable seat, one engine dependent hot water heater and one engine independent hot-water heater (with engine pre-heat). Complete controls and instrumentation for crane operation and LCD graphic display/controls for superstructure.

**Electrical system** 24 volt DC system, 2 batteries.

**Safety devices** Load moment device (LMD)-PAT-PDC system, hoist limit switch, lower limit switch on main winch and drum turn indicator, safety valves against pipe and hose rupture, holding valves on hydraulic cylinders.

**Optional Equipment** (at extra charge) Boom extensions: telescopic extension 9.0 m - 16.2 m long, 7.5 m Stinger section, 6 m insert section (max length 30.1 m of lattice construction all with offsets 5°, 20° and 40°), additional counterweight 16.8 t, selection of hook blocks, auxiliary winch (line pull 91 kN 1<sup>st</sup> layer), drive/steer and outrigger controls or only outrigger controls in superstructure cab, outrigger load display with monitoring, air conditioning. Special painting and lettering. Further optional equipment available upon request.



**Châssis** Construction mécano-soudée, en acier fin, résistante aux flexions et aux torsions.

**Calage** Calage à 4 points, complètement hydraulique. Commande des stabilisateurs latéralement à gauche et à droite du châssis, nivellement automatique. Calage: 7,5 m (aussi 5,0 m) x 7,74 m.

**Moteur** Mercedes-Benz diesel de 8 cylindres, modèle OM 502 LA (Euromot 2/EPA 2), refroidi par eau, de 350 kW (476 CV) à 2000 min<sup>-1</sup>. Couple: 2100 Nm (214 kpm) à 1080 min<sup>-1</sup>.

**Boîte de vitesses** Boîte automatique Allison HD 4560 P, avec convertisseur de couple hydrodynamique. Convertisseur avec embrayage "Lock-up", 6 vitesses AV et 1 vitesse AR. Boîte de transfert Steyr VG 1600 de deux gammes, avec marche route et marche tout-terrain.

**Entraînement**  
10 x 6 sur la route

**Ponts**  
1<sup>er</sup> essieu: directeur, non entraîné.  
2<sup>ème</sup> essieu: directeur, non entraîné.  
3<sup>ème</sup> essieu: directeur, entraîné.  
4<sup>ème</sup> essieu: directeur, entraîné.  
5<sup>ème</sup> essieu: directeur, entraîné.  
Réduction planétaire dans tous les essieux.

**Suspension** hydropneumatique-réglage d'inclinaison à suspension bloquée.

**Freins** Système de frein à air comprimé à double circuit. Frein de stationnement: frein à ressorts accumulateurs agissant sur le 3<sup>ème</sup>, 4<sup>ème</sup> et 5<sup>ème</sup> essieu. Frein continu: Frein sur échappement et étranglement.

**Pneus** 10 x 14.00 R 25

**Direction** Semi-bloc à double circuit, marque ZF. Direction mécanique du 1<sup>er</sup>, 2<sup>ème</sup> et 3<sup>ème</sup> essieu, à assistance hydraulique, avec pompe de direction auxiliaire. Direction de tous les essieux possible.

**Cabine** Cabine bi-place, construction en matière combinée acier / synthétique. Vitrage en verre de sécurité, sièges à suspension pneumatique. Chauffage à eau chaude relié au moteur. Organes de contrôle et de commande pour la conduite, affichage digital.

**Système électrique** 24 V courant continu, 2 batteries, connexion circuit électrique avec CAN-Bus. Équipement avec prise diagnostic et avec interprétation de code erreur de système FAUN CSS conforme aux normes CE.

**Équipement supplémentaire** (contre supplément de prix) Attache-remorque, chauffage auxiliaire, préchauffage du moteur, climatisation, entraînement 10 x 8, frein électrique, contrôle électronique de charge, pneus 16.00 R 25, pneus 20.5 R 25, roue de secours, peinture spéciale et inscription. Autres équipements supplémentaires sur demande.

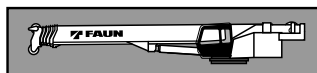

**Plate forme** Construction mécano-soudée résistante à la torsion. Couronne d'orientation à denture extérieure, permettant une rotation illimitée sur 360°.

**Moteur** Mercedes Benz diesel de 4 cylindres, modèle OM 904 LA, (Euromot 2/ EPA 2), refroidi par eau, de 125 kW (170 CV) à 2300 min<sup>-1</sup>. Couple 660 Nm (67 kpm) à 1200 min<sup>-1</sup>. (Puissance selon DIN 6270 B / DIN 6271).

**Système hydraulique** Diesel-hydraulique, à 3 circuits, 1 double pompe à pistons axiaux à régulation de puissance (à réglage électrique et "cross-sensing") et 1 pompe à engrenages.

**Commandes** 2 manipulateurs à commande en croix (4 sens), assistés électriquement.

**Flèche télescopique** 1 flèche de base et 4 éléments télescopiques, hydrauliquement télescopables aussi sous charge partielle. Flèche en forme de caisson avec une longueur de 12,8 m à 51,0 m.

**Mécanisme de relevage** 1 vérin différentiel muni de clapet de freinage de descente.

**Mécanisme de levage** Moteur hydraulique, tambour de levage avec boîte planétaire incorporée, frein d'arrêt à disques multiples à ressort, libéré lors du levage. Câble de levage avec dispositif "Super-Stop".

**Orientation** Moteur hydraulique, avec entraînement planétaire à 3 gammes. Frein de service actionné par l'intermédiaire d'une pédale et frein de stationnement. Vitesse de rotation 0 à 1,5 min<sup>-1</sup> en continu.

**Contrepoids** Poids total 8,2 t divisible, commandé depuis la cabine du grutier.

**Cabine** Cabine de grue spacieuse, en acier, basculable à 20°, avec vitrage de sécurité en verre teinté, siège réglable et amorti hydrauliquement, chauffage à eau chaude dépendant et indépendant du moteur (avec préchauffage du moteur), éléments de commande et de contrôle avec affichage digital pour travaux sur chantier.

**Système électrique** 24 V courant continu, 2 batteries.

**Dispositifs de sécurité** Limiteur de charge (CEC), système PAT-PDC, interrupteur de fin de course de levage et de treuil, indicateur du nombre de tours, soupapes de sécurité contre ruptures des conduites et flexibles, clapets sur vérins hydrauliques.

**Équipement supplémentaire** (contre supplément de prix) Rallonge de flèche (portée à 9,5 m à 16,2 m), rallonge mécanique, pièce intermédiaire 6 m (longueur maximale 30,1 m), inclinable à 5°, 20° et 40°, contrepoids additionnel 16,8 t maximal, sélection de mouffes, 2<sup>ème</sup> treuil de levage (effort au brin simple 91 kN 1er brin), commandement et conduite de la cabine de la superstructure, contrôle électronique de charge, climatisation, peinture spéciale et inscription. Autres équipements supplémentaires sur demande.

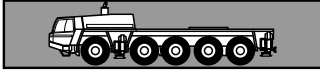

**Chasis portante** Construcción de acero de alta resistencia soldado, resistente a la torsión y a la flexión.

**Estabilización** Estabilizadores hidráulicos de 4 puntos. Posibilidad de manejo desde ambos lados del chasis portante, nivelación automático. Extensión de los estabilizadores: 7,5 m (y 5,0 m) x 7,74 m.

**Motor** Mercedes-Benz modelo OM 502 LA (Euromot 2/EPA 2), 8 cilindros, diesel, refrigerado por agua. Nominal 350 kW (476 HP) a 2000 min<sup>-1</sup>. Par 2100 Nm (214 kpm) a 1080 min<sup>-1</sup>.

**Transmisión** Transmisión automática Allison, tipo HD 4560 P, con convertidor de par hidrodinámico. Convertidor con embrague "Lock-up". 6 marchas adelante y 1 marcha atrás. Caja de distribución de dos escalones, marca Steyr, tipo VG 1600, con marcha de carretera y de todo terreno.

**Tracción** 10 x 6

#### Ejes

1° eje: de dirección, no accionado.

2° eje: de dirección, no accionado.

3° eje: de dirección, accionado.

4° eje: de dirección, accionado.

5° eje: de dirección, accionado.

Con bloqueo diferencial transversal en todos los ejes accionados.

**Suspensión** Suspensión hidroneumática con regulación de nivel.

**Sistema de frenos** Accionamiento neumático de doble circuito. Freno de estacionamiento del tipo muelles cargados, liberados por aire, sobre los ejes 3°, 4° y 5°. Freno continuo: sistema estrangulador constante y freno tipo estrangulación sobre el escape del motor diesel.

**Neumáticos** 10 x 14.00 R 25

**Dirección** Hidráulica ZF semibloqueo de doble circuito. Giro mecánico sobre los ejes 1°, 2° y 3°, asistido hidráulicamente. Bomba hidráulica de emergencia accionada por la transmisión. Dirección de todos los ejes posible.

**Cabina** Cabina para dos personas, en construcción de acero y fibra de vidrio. Cristales de seguridad, asiento con suspensión neumática, calefacción por agua caliente del motor. Elementos de control e instrumentos para circulación por carretera.

**Sistema eléctrico** Sistema de 24 V c.c. con 2 baterías, conexiones eléctricas integradas en el sistema CAN-Bus, sistema integrado de diagnóstico Faun-CSS. El sistema eléctrico cumple todas las normativas de la EG.

**Opcionales** (con suplemento de precio) Embrague de remolque, calefacción adicional, precalefacción del motor, climatización, tracción 10 x 8, freno eléctrico, control carga, gatos de apoyo, neumáticos 16.00 R 25, rueda de repuesto, pintura especial y rotulación. Opcionales adicionales a petición del cliente.

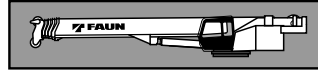

**Superestructura** Construida en aceros soldados, resistente a la torsión. Corona de giro con rodamiento de una fila de bolas con dientes externos para giro continuo de 360°.

**Motor** Motor Mercedes-Benz, modelo OM 904 LA, (Euromot 2/EPA 2), 4 cilindros, diesel, refrigerado por agua. Nominal 125 kW (170 HP) a 2300 min<sup>-1</sup>. Par 660 Nm (67 kpm) a 1200 min<sup>-1</sup>. (Potencia del motor según DIN 6270B/DIN 6271).

**Sistema hidráulico** Sistema hidráulico de 3 circuitos, 1 bomba doble de pistones axiales de caudal variable (regulable eléctricamente) y una bomba de engranajes.

**Mandos** 2 palancas de control de tipo joy-stick para movimientos simultáneos de la grúa (4 direcciones), asistidos eléctricamente.

**Pluma telescópica** 5 secciones del tipo cajón, un tramo base y 4 telescópicos. Los tramos se pueden telescopar hidráulicamente bajo carga. Longitud de 12,8 m a 51,0 m.

**Elevación de pluma** Mediante un cilindro hidráulico de doble efecto con válvula de retención integrada.

**Cabrestante principal** Motor hidráulico de pistones axiales y caudal fijo. Tambor del cabrestante con reducción planetaria y freno de discos múltiples con muelles cargados. Cable de elevación con sistema de enhebrado fácil y "Super-Stop".

**Sistema de giro** Motor hidráulico de caudal fijo con reducción planetaria de tres etapas. Freno de servicio controlado por pedal. Freno de estacionamiento. Velocidad de giro variable de 0 a 1,5 min<sup>-1</sup>.

**Contrapeso** Peso total de 8,2 t, divisible, accionado desde la cabina de la grúa.

**Cabina de la grúa** Inclinable hasta 20°. Construida en acero, espaciosa y confortable, con cristales coloreados de seguridad. Asiento del operador regulable amortiguado hidráulicamente, calefacción por agua caliente dependiente e independiente del motor (con precalefacción del motor). Controles, instrumentos y mandos de conducción para la operación de la grúa y para el desplazamiento en obra. Mandos para nivelación y extensión de los estabilizadores.

**Sistema eléctrico** Sistema a 24 V c.c. con 2 baterías.

**Dispositivos de seguridad** Dispositivo de momento de carga (sistema PAT-PDC), interruptor de límite de elevación y de carrera del cabrestante. Indicador de vueltas del tambor. Válvulas de seguridad contra rotura de tuberías y latiguillos, válvulas de retención en los cilindros hidráulicos.

**Opcionales** (con suplemento de precio) Plumín de 9,5 m a 16,2 m, Stinger de 7,5 m, extensión adicional de celosía de 6 m (longitud total 30,1 m) angulable en 5°, 20° y 40°, contrapeso máximo de 16,8 t, diferentes ganchos, 2° cabrestante de 91 kN. Conducción desde la cabina de la grúa, manejo de los gatos desde la cabina de la grúa, indicador de carga de gatos en la cabina de la grúa, aire acondicionado, pintura especial y rotulación. Opcionales adicionales a petición del cliente.



Hakenhöhen / Kopfhöhen  
 Hook height / Tip height  
 Hauteurs sous crochet / Hauteurs tête de flèche  
 Altura del gancho / Altura de la punta

